

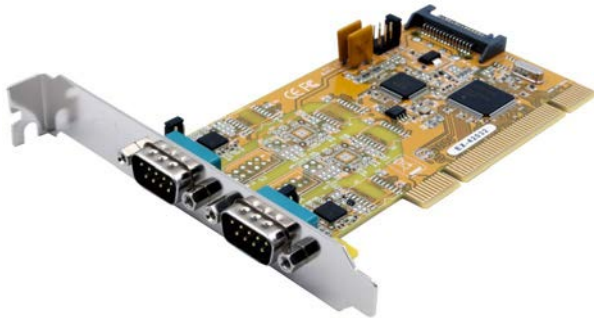

EX-42032

Scheda PCI RS-232/422/485
con 2 connettori a 9 pin



RS-232/422/485 PCI Card
with 2 x 9 Pin Connector

Germany:
EXSYS Vertriebs GmbH
Industriestrasse 8
61449 Steinbach
www.exsys.de

Switzerland:
EXSYS Vertriebs GmbH
Dübendorfstrasse 17
8602 Wangen
www.exsys.ch

Italy:
EXSYS Italia Srl
Via Belvedere, 45/B
I-22100 Como
www.exsys.it



Vers. 1.0 / 08.01.20

Indice

1.	Descrizione	3
2.	Contenuto Confezione	3
3.	Struttura e Attacchi	4-5
	1. Struttura	4
	2. Attacchi	4-5
4.	Impostazioni Switch e dei ponticelli	5-8
	1. Impostazioni Switch	5-8
	2. Impostazioni dei ponticelli	8
5.	Installazione Hardware	9
6.	Installazione Driver	9-11
7.	Dati tecnici	11

Index

1.	Description	12
2.	Extent of Delivery	12
3.	Layout and Connections	13-14
	1. Layout	13
	2. Connections	13-14
4.	Switch and Jumper Settings	14-17
	1. Switch Settings	14-17
	2. Jumper Settings	17
5.	Hardware Installation	18
6.	Driver Installation	18-20
7.	Technical Information	20

1. Descrizione

L'EX-42032 è una scheda seriale PCI RS-232/422/485 con 2 porte seriali FIFO 16C95x per il collegamento di periferiche seriali RS-232 ad alta velocità (ad es. terminali, modem, plotter ecc.). Il bus seriale PCI supporta in modo ottimale le prestazioni del veloce chipset FTDI con cache FIFO da 256 byte. L'EX-42032 garantisce quindi una trasmissione sicura dei dati e prestazioni eccellenti fino a 921KBaud/s per ogni dispositivo collegato! Supporta tutti gli slot PCI e PCI-X con 3,3 V e 5 V. Non è possibile impostare manualmente gli indirizzi di I/O e gli interrupt, in quanto le impostazioni della scheda vengono effettuate automaticamente dal sistema (BIOS) e al momento dell'installazione del sistema operativo. È possibile utilizzare i ponticelli per reindirizzare 5V o 12V al pin 9 della connessione seriale. Assicurarsi che anche i dispositivi collegati supportino questa funzione. Le uscite possono essere configurate indipendentemente l'una dall'altra come RS-232, RS-422, RS-485 a 2 fili o RS-485 a 4 fili.

Caratteristiche:

- PCI e PCI-X, 3,3Volt o 5Volt
- Da 300 Baud a 921,6 KBaud
- RS-232, RS-422, RS-485 a 2 fili e RS-485 a 4 fili
- Windows 200x/ XP/ Vista/ 7/ 8.x/ 10/ Server 20xx/ Linux/ Mac OS
- **Certificato per CE**   

2. Contenuto Confezione

Prima di installare l'EX-42032 nel PC, verificare il contenuto della confezione, che ci sia:

- EX-42032
- Driver su CD
- Istruzioni per l'uso

3. Struttura e Attacchi

3.1 Struttura

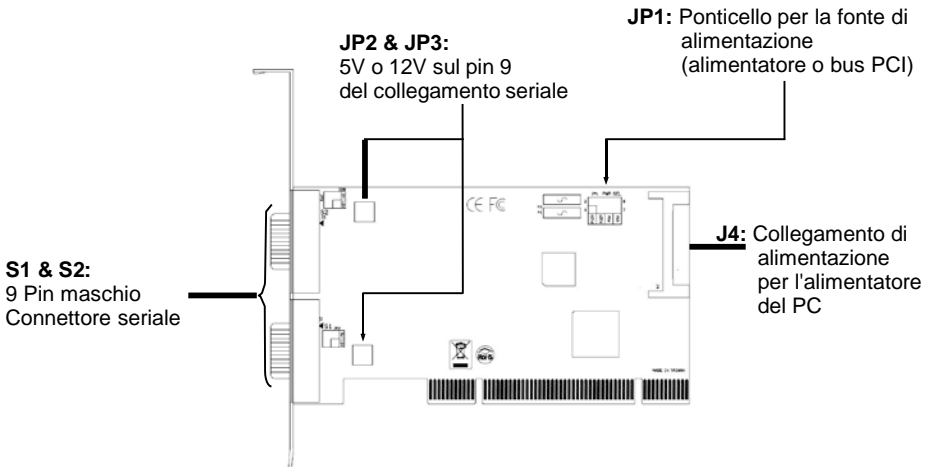

3.2 Attacchi

RS232 Pin Assignment

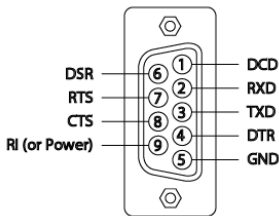

RS422 and RS485-4wire
Pin Assignment

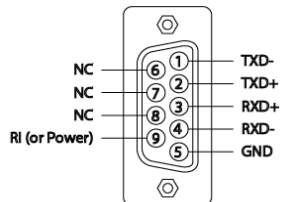

DB9 (EX-42032)

DB9 (Dispositivo)

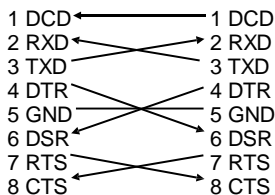

DB9 (EX-42032)

DB9 (Dispositivo)

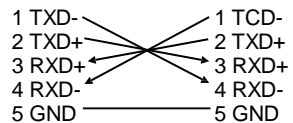

3. Struttura e Attacchi

3.2 Struttura

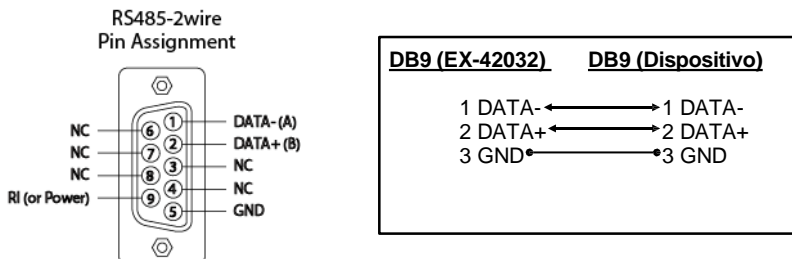

J4:



Pin	Designazione	Pin	Designazione	Pin	Designazione
1	3.3 Volt (Arancio)	7	5 Volt (pre-charge)	13	12 Volt (pre-charge)
2	3.3 Volt (Arancio)	8	5 Volt (Rosso)	14	12 Volt (Giallo)
3	3.3 Volt (pre-charge)	9	5 Volt (Rosso)	15	12 Volt (Giallo)
4	Ground (Nero)	10	Ground (Nero)		
5	Ground (Nero)	11	Riservato		
6	Ground (Nero)	12	Ground (Nero)		

Se il ponticello **JP1** è impostato su X5V o X12V, la scheda deve essere collegata al collegamento di alimentazione dell'alimentatore del PC! A tale scopo utilizzare il collegamento di alimentazione J4!

Prestare attenzione alla corretta polarità!

Attenzione! Non inserire o disinserire mai il connettore quando il PC è acceso!

4. Impostazione Switch

4.1 Impostazione Switch

Sul retro della scheda EX-42032 sono presenti due interruttori DIP a 8 pin, uno separato per ciascuna porta. Gli interruttori DIP a 8 pin sono responsabili della modalità (RS-232, RS-422, RS-485 a 2 fili o RS-485 a 4 fili) e della terminazione dei segnali RX+, RX-, TX+ e TX- (vedi figura a pagina 6). Le impostazioni possono essere impostate individualmente per ciascuna porta seriale. Il commutatore DIP S1 è responsabile della porta 1 e il secondo commutatore DIP S2 è responsabile della porta 2. Le seguenti illustrazioni alle pagine 6, 7 e 8 mostrano l'impostazione del selettore di modalità e dei selettori di terminazione. Le opzioni di impostazione degli interruttori di modalità e di terminazione sono stampate anche sul retro della scheda di circuito.

4. Impostazione Switch e Ponticelli

4.1 Impostazioni Switch

Mode & Terminator Switch (S1 & S2_Mode)

Modo	RS-232	RS-422	RS-485 2-fili	RS-485 4-fili
Porta 1				
Porta 2				

Resistenze Off

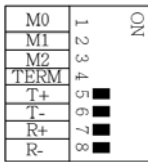

Resistenze On

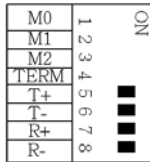

Terminatore Off

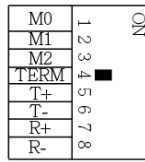

Terminatore On

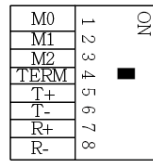

4. Impostazione Switch e Ponticelli

4.1 Impostazione Switch

Resistenze per le modalità RS-422, RS-485 a 2 fili e RS-485 a 4 fili:

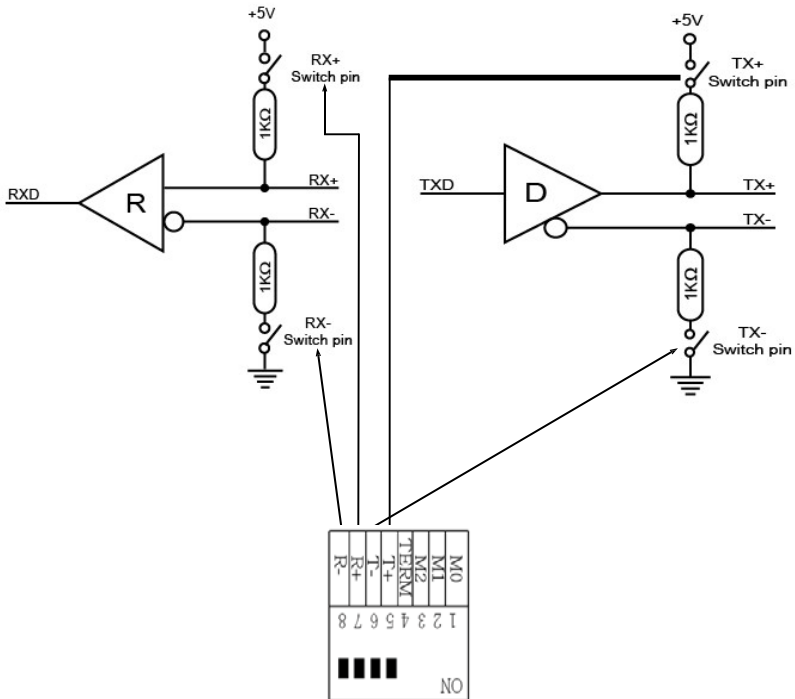

5. Installazione Hardware

Per l'installazione della scheda, attenersi alle seguenti istruzioni. Poiché esistono notevoli differenze tra i vari PC, possiamo fornire solo istruzioni generali per l'installazione dell'EX-42032. In caso di dubbi, consultare le istruzioni per l'uso del proprio sistema informatico.

1. Spegnerne il computer e tutte le periferiche collegate e scollegare tutti i dispositivi dalla rete elettrica.
2. Allentare le viti dell'alloggiamento sul retro del computer e rimuovere con cautela l'alloggiamento.
3. Individuare uno slot PCI libero e inserire con cautela la scheda nello slot PCI selezionato. Assicurarsi che si tratti dello slot corretto!
4. Assicurarsi che la scheda sia inserita correttamente e che non vi siano cortocircuiti. Non forzare l'inserimento della scheda!
5. Installare ora l'alimentatore esterno per alimentare la scheda madre e, se necessario, la fonte di alimentazione selezionata. (vedere i collegamenti J4)
6. Quindi fissare la scheda all'alloggiamento con una vite.
7. Ora è possibile richiudere l'alloggiamento del computer con le viti.

6. Installazione Driver

Windows

Una volta completata l'installazione dell'hardware, il sistema operativo riconosce automaticamente la scheda e la installa! Se i driver non vengono installati automaticamente, è necessario installare manualmente due driver. Uno è il driver host USB e l'altro è il driver USB-seriale. A tale scopo, inserire il CD dei driver nell'unità CD-ROM (ad es. unità D:) e avviare il "SETUP" che si trova nella cartella "uPD720201_202" (vedi figura): Seguire le istruzioni di installazione e completare l'installazione. **Importante!** Riavviare il PC dopo l'installazione.



6. Installazione Driver

Windows

In secondo luogo, installare il driver da USB a seriale. Aprire la cartella “**USB_to_IO/FTDI**”. Selezionare la cartella del proprio sistema operativo e installare i driver (vedi figura). Seguire le istruzioni di installazione e completare l'installazione. **Importante!** Riavviare il PC dopo l'installazione.

Per i sistemi operativi server vengono installati i seguenti driver:

Windows Server 2003	=	Driver per XP
Windows Server 2008	=	Driver per VISTA
Windows Server 2008R2	=	Driver per Windows 7
Windows Server 2012	=	Driver per Windows 8.x
Windows Server 2012R2	=	Driver per Windows 10

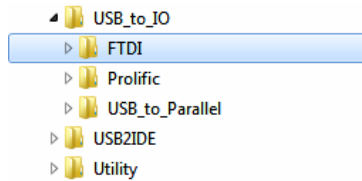

VERIFICA INSTALLAZIONE DRIVER

Aprire la >**Gestione dispositivi**<. A questo punto si dovrebbero vedere le seguenti voci in “**Porte (COM e LPT)**” e “**Controller USB**”:



Se queste voci o altre simili sono presenti, la scheda è installata correttamente.

CAMBIARE IL NUMERO DELLA PORTA

È possibile modificare il numero di porta anche aprendo la gestione dei dispositivi, ad esempio “**COM3**” “**Impostazioni porta**” e aprendo ‘**Avanzate**’. Ora è possibile scegliere tra **COM3 a COM256!**

6. Installazione Driver

Linux & Mac OS

I driver per i sistemi Linux e Mac OS si trovano anche nella cartella "USB_to_IO/FTDI". Selezionare ora la cartella del proprio sistema operativo e installare i driver (vedi figura).

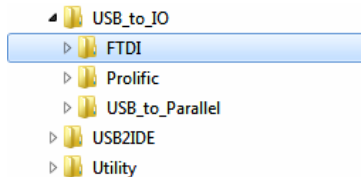

Poiché le singole distribuzioni e versioni del Kernel differiscono notevolmente tra loro, purtroppo non siamo in grado di fornire istruzioni per l'installazione. Seguite le istruzioni di installazione per le porte I/O standard della vostra versione di Linux/Unix o Mac OS. In alcune versioni più recenti, la scheda viene addirittura installata automaticamente all'avvio.





7. Dati Tecnici

Chip-Set:	FTDI
Trasferimento Dati:	Da 300 Baud a 921.6 Kbaud
Attacchi:	Connettore 2x 9 Pin Seriale RS-232, 1x connessione di alimentazione SATA
Sistema Hardware:	PCI oppure PCI-X, 3.3Volt o 5Volt
Sistema Operativo :	Windows 200x/ XP/ Vista/ 7/ 8.x/ 10/ Server 200xx Linux/ Mac OS
Temperatura d'esercizio:	Da 0° a 55° Celsius
Temp. di conservazione:	Da -40° a 75° Celsius
Umidità relativa:	Dal 5% al 95%
Alimentazione:	5V o 12V tramite slot PCI o connessione di alimentazione SATA
Dimensione:	132,30 x 120,00 mm
Peso:	200g

1. Description

The EX-42032 is a plug & play high-speed serial RS-232/422/485 expansion card for the PCI bus. The EX-42032 provides two 9 pin high speed RS-232/422/485 serial ports. It uses data transfer rates up to 921Kbaud/s. The EX-42032 design utilizes the FTDI chipset with 256-byte buffer, which incorporates the latest in high speed interface technology. In combination with the fast PCI bus it provides a secure and very high data transfer on each port. It supports PCI & PCI-X slots with 3.3V and 5Volt. It is not possible to change the address or IRQ settings manually, they will be obtained automatically by the system BIOS and operating system. With the jumpers you can enable 5V or 12V power to pin 9. Please note if you use power to pin 9 your peripheral device must support it. The serial ports can be configured as RS-232, RS-422, RS-485 2-wire or RS-485 4-wire.

Features:

- PCI & PCI-X, 3.3Volt or 5Volt
- 300 Baud up to 921.6 KBaud
- RS-232, RS-422, RS-485 2-wire and RS-485 4-wire
- Windows 200x/ XP/ Vista/ 7/ 8.x/ 10/ Server 20xx/ Linux/ Mac OS
- **Certificate for**    

2. Extent of Delivery

Before you install the EX-42032 in your PC, you should first check the contents of the delivery:

- EX-42032
- Driver CD
- Manual

3. Layout and Connections

3.1 Layout

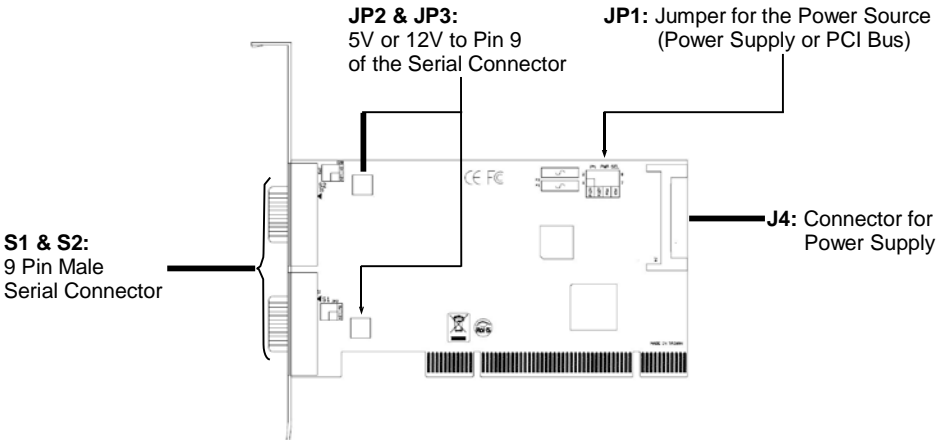

3.2 Connections

RS232 Pin Assignment

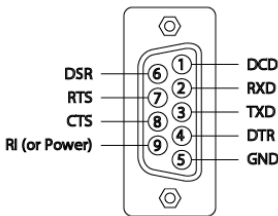

RS422 and RS485-4-wire
Pin Assignment

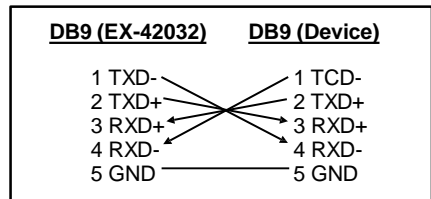
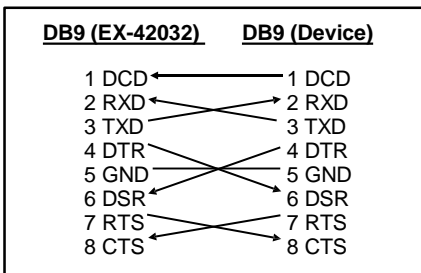
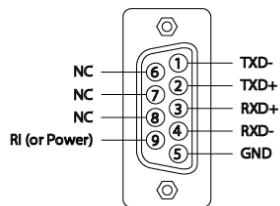

3. Layout and Connections

3.2 Connections

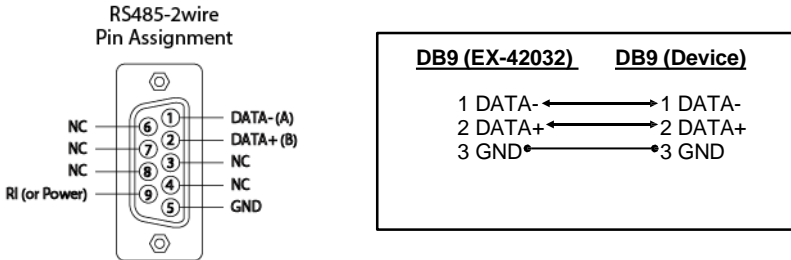

J4:



Pin	Assignment	Pin	Assignment	Pin	Assignment
1	3.3 Volt (Orange)	7	5 Volt (pre-charge)	13	12 Volt (pre-charge)
2	3.3 Volt (Orange)	8	5 Volt (Red)	14	12 Volt (Yellow)
3	3.3 Volt (pre-charge)	9	5 Volt (Red)	15	12 Volt (Yellow)
4	Ground (Black)	10	Ground (Black)		
5	Ground (Black)	11	Reserved		
6	Ground (Black)	12	Ground (Black)		

If jumper JP1 is set to X5V or X12V, you must connect the card with the PC power supply. It must be connected on the power connector J4!

Please make sure you connect the plug in the right direction!

Attention! Never connect or release the plug while the PC is supplied with power!

4. Switch and Jumper Settings

4.1 Switch Settings

There are two 8-pin DIP-switches on the backside of the board at the EX-42032. For each port there is a separate DIP-switch. The 8-pin DIP-switches are for the modes (RS-232, RS-422, RS-485 2-wire or RS-485 4-wire) and for the signal termination for RX+, RX-, TX+ and TX- (see picture on page 15). The settings can be set individually for each serial port. The DIP-switch are responsible for the port 1 (S1) and the second DIP-switch are responsible for the port 2 (S2). The following images on page 15, 16 and 17 you can see the setting of the mode switch and terminator switch. Additionally the setting of the mode switch are printed on the back of the board.

4. Switch and Jumper Settings

4.1 Switch Settings

Mode & Terminator Switch (S1 & S2_Mode)

Modes	RS-232	RS-422	RS-485 2-wire	RS-485 4-wire
Port 1				
Port 2				

Resistor Off

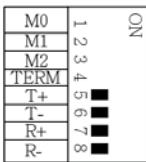

Resistor On

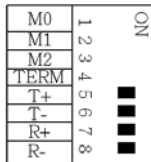

Terminator Off

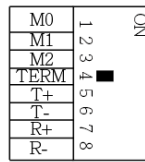

Terminator On

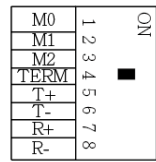

4. Switch and Jumper Settings

4.1 Switch Settings

Resistors for RS-422, RS-485 2-wire and RS-485 4-wire mode:

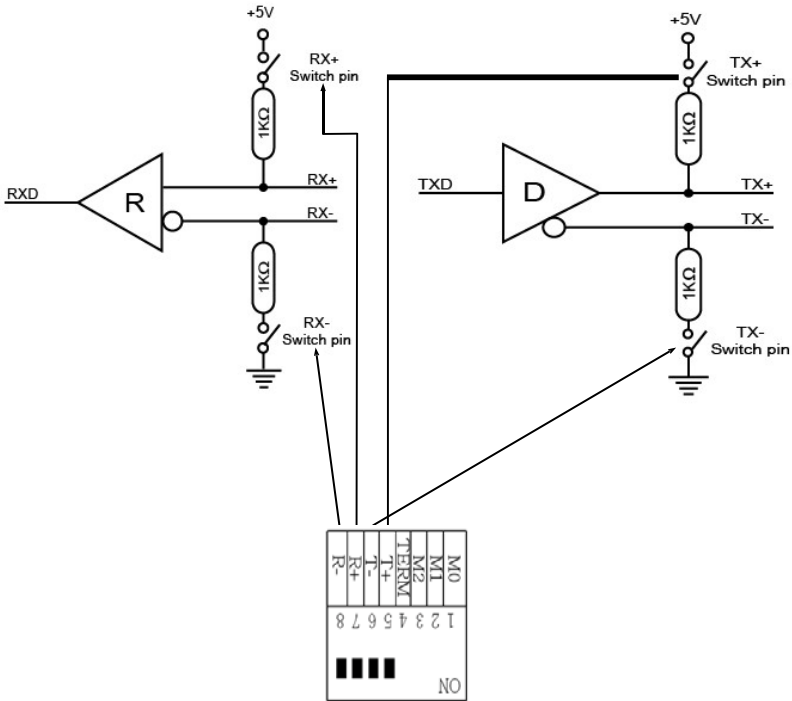

4. Switch and Jumper Settings

4.1 Switch Settings

Termination for RS-422, RS-485 2-wire and RS-485 4-wire mode:

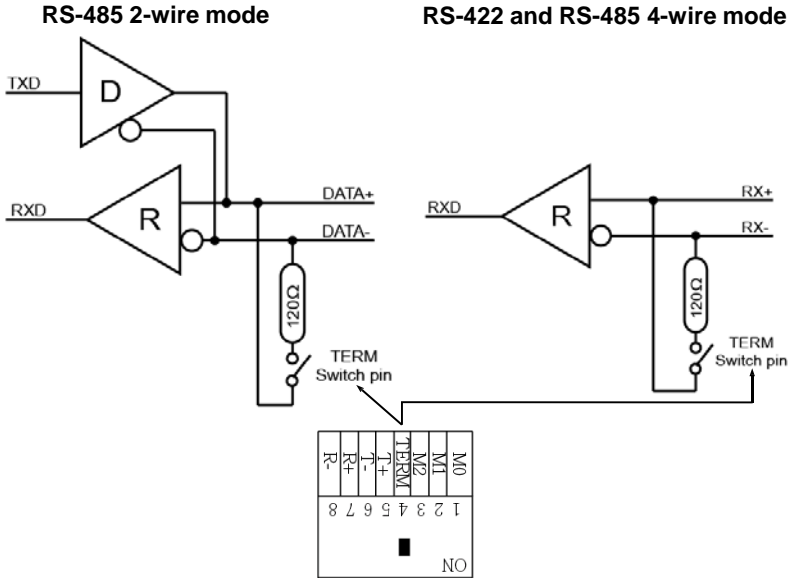

4.2 Jumper Settings

JP2 & JP3:



5V = At pin 9 is now a voltage of +5V DC.
(Factory Setting)

12V = At pin 9 is now a voltage of +12V DC.

There are two jumper on the board, so you can make the settings individually for all serial ports. The voltage adjustment can be made with the jumper JP1. But this should not be adjusted for standard applications.

JP1:

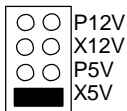

If you have the jumper JP2 & JP3 set to 5V or 12V, you can adjust the voltage with the jumper JP1. There are 4 different power sources. **(Attention!** Connector J4 must be connected to the power supply!)

X5V = 5Volt from PC Power Supply (Factory Setting)

P5V = 5Volt from Mainboard

X12V = 12Volt from PC Power Supply

P12V = 12Volt from Mainboard

5. Hardware Installation

If you are ready with the jumper settings, please proceed with the following installation instructions. Because there are large differences between PC's, we can give you only a general installation guide for the EX-42032. Please refer to your computer's reference manual whenever in doubt.

1. Turn off the power to your computer and any other connected peripherals.
2. Remove the mounting screws located at the rear and/or sides panels of your Computer and gently slide the cover off.
3. Locate an available expansion slot and remove its covers from the rear panel of your computer. Make sure it is the right expansion slot for the card (see card description)
4. Align the card with the PCI slot and then gently but firmly, insert the card. Make sure the card is seated and oriented correctly. Never insert the card by force!
5. Now install the external power supply to relieve the mainboard and with the power source selected if necessary. (see connections J4)
6. Then connect the card with a screw to the rear panel of the computer case.
7. Gently replace your computer's cover and the mounting screws.

6. Driver Installation

Windows

After completing the hardware installation, the operating system will automatically the card and install this! If the driver should not be installed automatically, you must manually install two drivers. One ist the USB host driver and the other is the USB to serial driver. for this insert the driver CD into you CD-ROM drive (eg drive D:) and then start the „**SETUP**“ which is located in folder „uPD720201_202“ (see picture): Follow the hardware assistant and finish the installation. **Important!** Restart your PC in any case after installing the drivers.



6. Driver Installation

Windows

Second, please install now the USB to serial driver. Open the folder „USB_to_IO/FTDI“. Please select the folder with your operating system and install the driver (see Picture). Follow the hardware assistant and finish the installation. **Important!** Restart your PC in any case after installing the drivers.

Use the following driver for the following Windows Server Version:

Windows Server 2003	=	XP Driver
Windows Server 2008	=	VISTA Driver
Windows Server 2008R2	=	Windows 7 Driver
Windows Server 2012	=	Windows 8.x Driver
Windows Server 2012R2	=	Windows 10 Driver

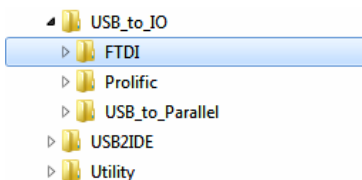

CHECK INSTALLED DRIVER

Open the >**Device manager**<. Now you should see at „**Ports (COM & LPT)**“ and at „**USB-Controller**“ the following new entry's:



If you see this or a similar information the device is installed correctly.

CHANGE PORT NUMBER

If you like to change the port number for example COM3 to COM5, open the „**Device Manager**“ click at „**COM3**“, „**Settings**“ and then „**Advance**“. There you can change between COM3 till COM256.

6. Driver Installation

Linux & Mac OS

The drivers for Linux & Mac OS systems are also in the same folder „USB_to_IO/FTDI“. Please select the folder with your operating system and install the driver (see Picture).

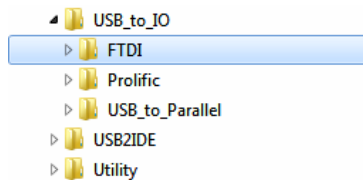

Because each individual distribution and kernel version of Linux is different, sadly we can't provide a installation instruction. Please refer to the installation manual for standard I/O ports from your Linux/Unix version! In some newer versions of Linux the card will even be installed automatically after starting Linux.

7. Technical Information

Chip-Set:	FTDI
Data Transfer Rate:	300 Baud up to 921.6 KBAud
Connectors:	2x 9 Pin serial RS-232 Connector, 1x SATA Power Connector
Hardware System:	PCI or PCI-X, 3.3Volt or 5Volt
Operating System:	Windows 200x/ XP/ Vista/ 7/ 8.x/ 10/ Server 200xx Linux/ Mac OS
Operating Temperature:	32°F to 55°Fahrenheit
Storage Temperature:	-40°F to 167°Fahrenheit
Rel. Humidity:	5% to 95%
Power:	5V or 12V via PCI Slot or SATA Power Connector
Size:	132,30 x 120,00 mm
Weight:	200g